

EATON XTJP / XTJY Jockey Pump Controllers



Description

1.	INSTALLATION AND MOUNTING OF THE CONTROLLER	3
2.	SYSTEM PRESSURE CONNECTIONS	3
3.	ELECTRICAL CONNECTIONS	3
3.1	ELECTRICAL CHECKOUT INSTRUCTIONS.....	4
	3.1.1 Motor Rotation Check	4
	3.1.2 Starting and Stopping	4
	3.1.3 Motor Circuit Protector / Overload Relay Trip Setting.....	4
	3.1.4 Circuit Breaker Trip Settings	4
	3.1.5 Run Period Timer (Optional).....	4
	FIGURE 1: ELECTRICAL WIRING SCHEMATIC - Three Phase.....	5
	FIGURE 2: DIMENSIONAL DRAWING - NEMA 2.....	6
	FIGURE 3: ELECTRICAL WIRING SCHEMATIC - WYE DELTA (Star-Delta).....	7
	FIGURE 4: DIMENSIONAL DRAWING - WYE DELTA (Star-Delta).....	8
4.	DIGITAL DISPLAY.....	9
4.1	PROGRAMMING	9, 10, 11

INSTALLATION & MAINTENANCE MANUAL FOR JOCKEY PUMP CONTROLLERS

In order to familiarize yourself with the Jockey Pump Controller, please read the instruction manual thoroughly and carefully. Retain the manual for future reference.

1. Installation and Mounting of the Controller

Carefully unpack the controller and inspect thoroughly.

It is recommended that the controller is located as close as is practical to the motor it controls

The controller is not free standing and must be bolted securely to a wall. For dimensional and weight data please refer to the respective data sheets for the Jockey Pump Controller.

2. System Pressure Connection

The Jockey Pump Controller is equipped with a Pressure Transducer. The controller is provided with a 1/4" NPT female system pressure connection located on the bottom, external side of the enclosure. The connection should be installed as per NFPA, pamphlet No. 20.

NOTE: Water lines to the pressure transducer must be free from dirt and contamination.

The pressure should not exceed what the pressure transducer is rated for.

3. Electrical Connections

All electrical connections should meet national and local electrical codes and standards.

The controller should be located or so protected that they will not be damaged by water escaping from pumps or pump connections. Current carrying parts of controllers shall be a minimum of 12 inches (305 mm) above the floor level.

Prior to starting verify all data on the nameplate such as, catalog number, AC line voltage and horsepower.

Inspect all electrical connections, components and wiring for any visible damage and correct as necessary. Ensure that all electrical connections are tightened before energization.

Install necessary conduit using proper methods and tools.

Incoming AC line voltage is clearly marked L1, L2, L3 and ground, located at the top of the breaker.

3.1 Electrical Checkout Instructions

WARNING: *The following procedures should be carried out by a qualified electrician familiar with the electrical safety procedures associated with this product and its associated equipment.*

- 3.1.1 **Motor Rotation Check:** With the controller energized, move the H.O.A. selector switch to “HAND” then back to “OFF” immediately to check the direction of the motor and pump rotation. If rotation direction is not correct, open the breaker and reverse the phase sequence of the load terminals of the contactor T1, T2, T3 or at the motor terminals.
- 3.1.2 **Starting and Stopping:** Energize the controller. With the H.O.A. selector switch set to “AUTO”, if the system water pressure is lower than the pressure transducer set-point pressure (1Lo), the pump will start. The pump will stop when pressure is above the stop point (1Lo+HYS). If the optional running period timer is included, the pump will run for the set time and then stop, provided the pressure is above the pressure stop point (1Lo+HYS). For manual operation, set the H.O.A. selector switch to “HAND’ to start the pump and “OFF” to stop.
- 3.1.3 **Motor Circuit Protector / Overload Relay Trip Setting:** The trip setting should be set to match the motor nameplate full load amps.
- 3.1.4 **Circuit Breaker Trip Settings:** When a Circuit Breaker is installed, the trip setting must be set as indicated on the chart on the inside of the controller.
- 3.1.5 **Run Period Timer:** (Optional) Adjust the RPT dial to the desired run period time setting. Three rotary adjustment dials are provided on the front of the timer.

Run Period Timer Factory Defaults

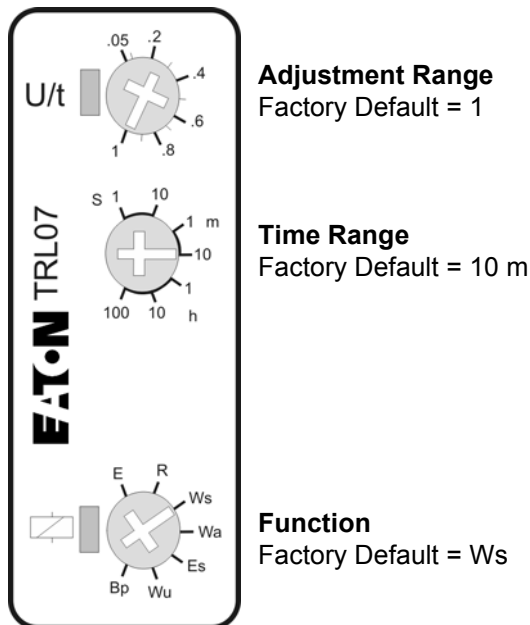

(Ws) Single Shot - leading edge with control input

The supply voltage U must be constantly applied to the device (green LED U/t illuminated).

When the control contact S is closed, the output relay R switches into on-position (green LED U/t illuminated) and the set interval begins (green LED U/t flashes).

After the interval has expired (green LED U/t illuminated) the output relay switches into off-position (yellow LED not illuminated).

During the interval, the control contact can be operated any number of times.

A further cycle can only be started when the cycle run has been completed.

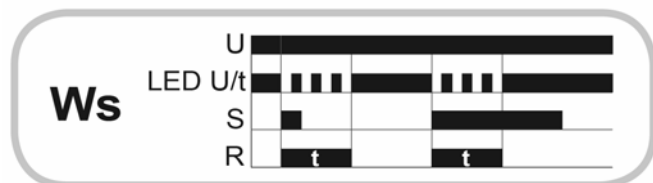

Figure 1: Electrical Wiring Schematic - Three Phase

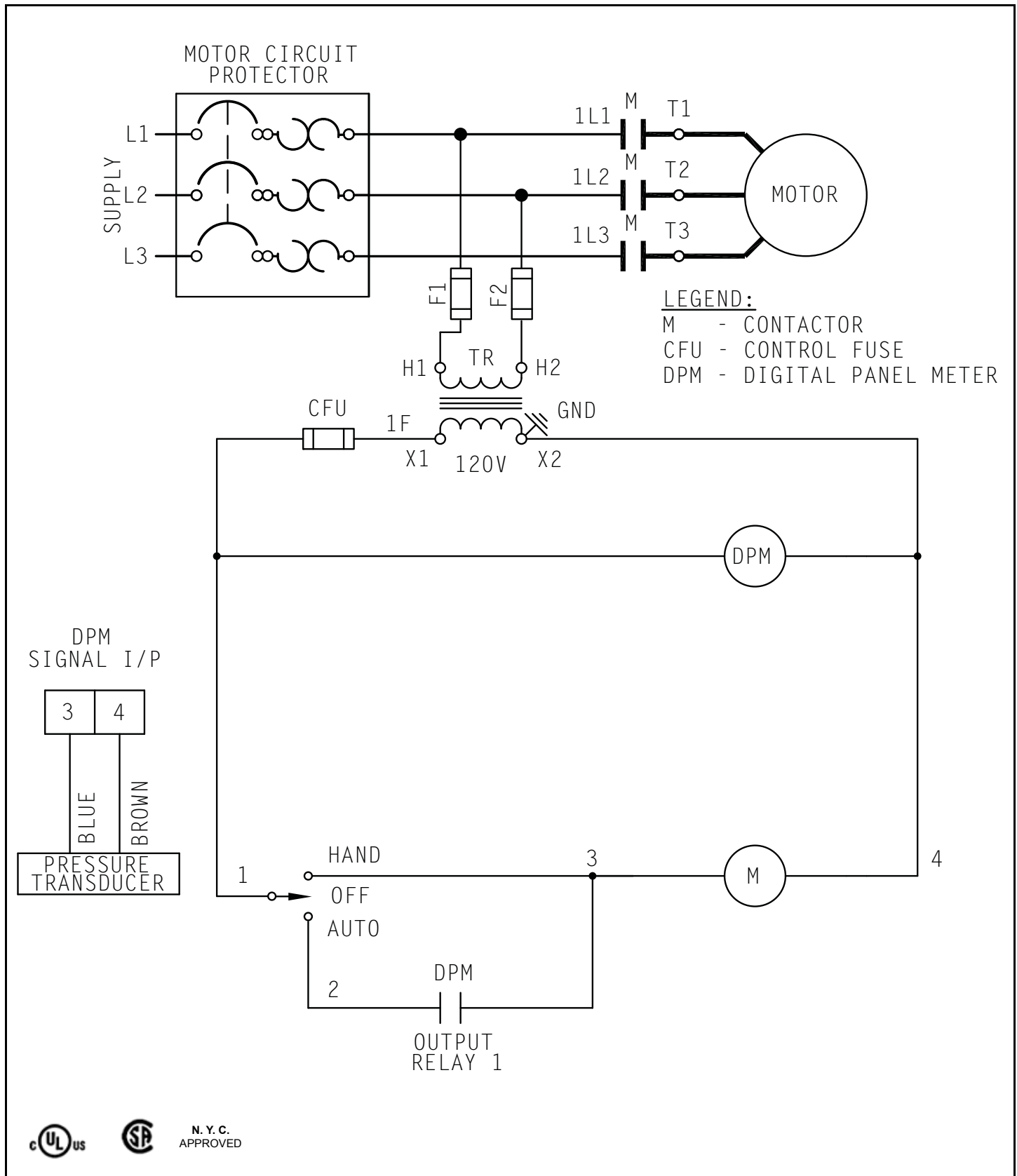
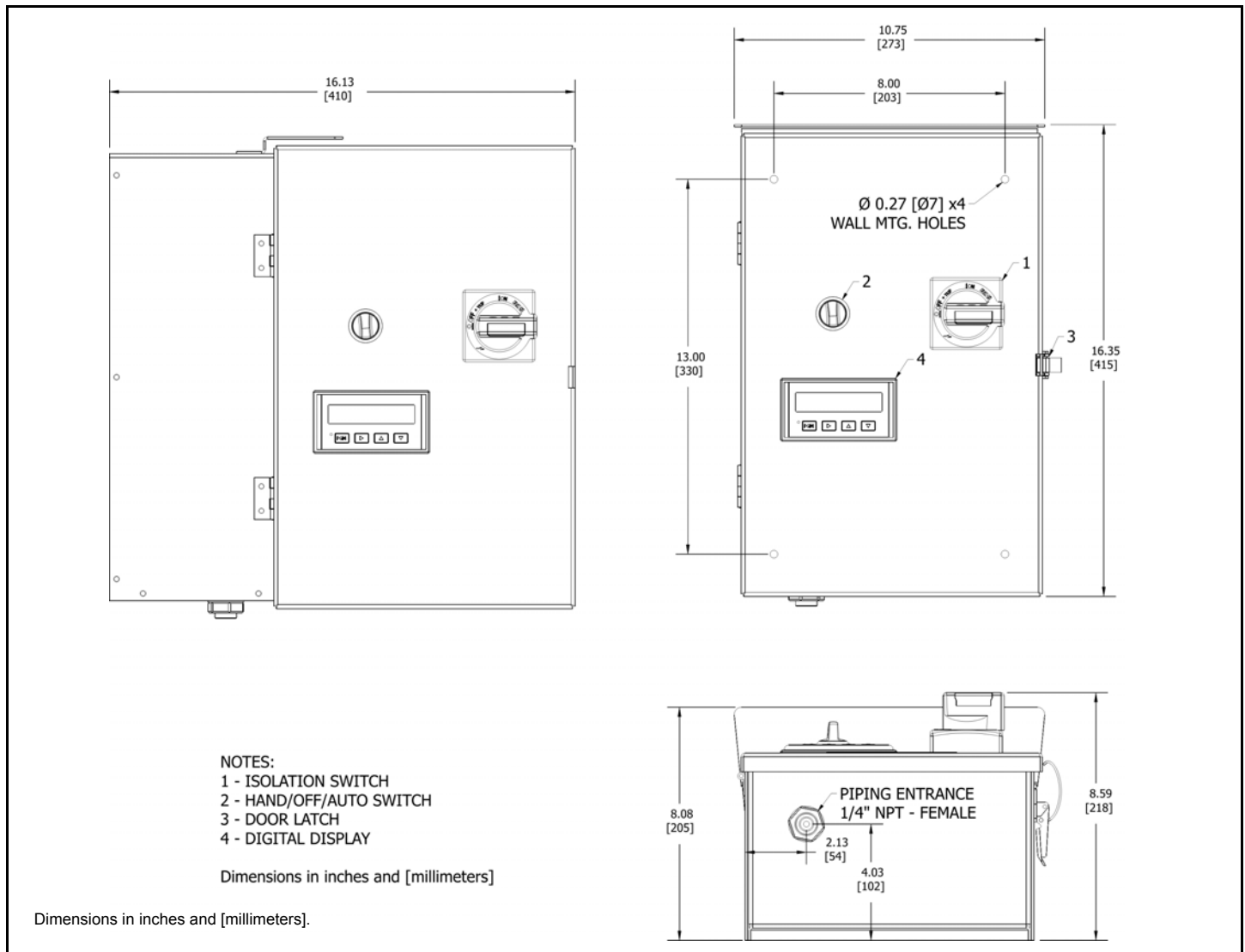

Figure 2: Standard Enclosure - Type NEMA 2



200 - 208V		220 - 240V		380 - 415V		440 - 480V		550 - 600V	
Motor Hp	Withstand Rating (kA)	Motor Hp	Withstand Rating (kA)	Motor Hp	Withstand Rating (kA)	Motor Hp	Withstand Rating (kA)	Motor Hp	Withstand Rating (kA)
0.33 - 3	65	0.33 - 3	65	0.33 - 5	65	0.33 - 7.5	65	0.33 - 10	18
4	50	4	50	7.5 - 10	18	10	50		
5 - 10	18	5 - 10	18			15 - 20	18		
120V 1Ø		240V 1Ø		Approx. Weight					
Motor Hp	Withstand Rating (kA)	Motor Hp	Withstand Rating (kA)	Lbs (Kg)					
0.33 - 0.5	65	0.33 - 2	65	22					
0.75	50	3 - 5	18	(10)					
1 - 2	18								

NOTES:
 1. All enclosures finished in Red.
 2. Cable Entrance either top or bottom.
 3. Standard Enclosure type NEMA 2.



Figure 3: Electrical Wiring Schematic - Wye Delta (Star-Delta)

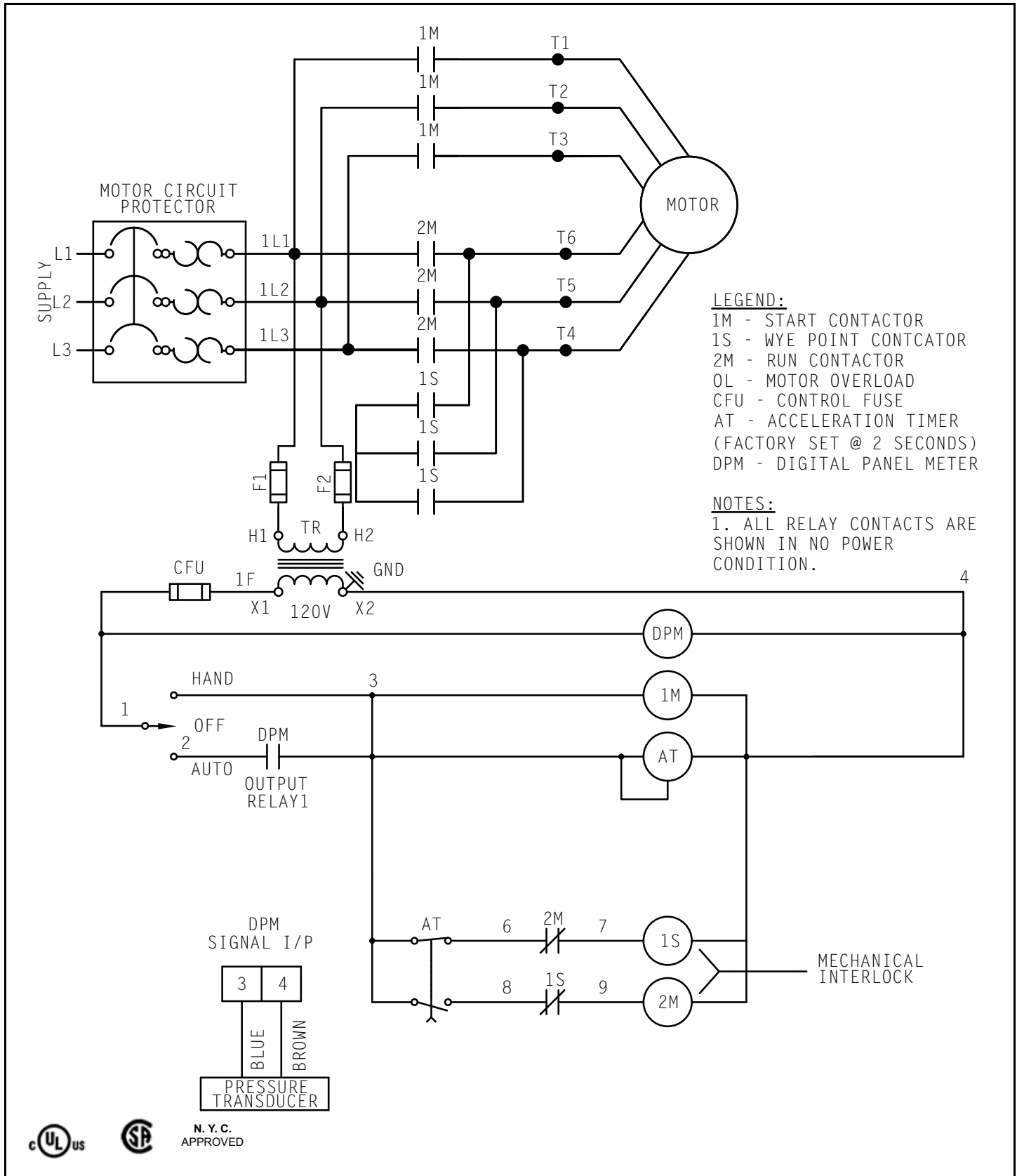
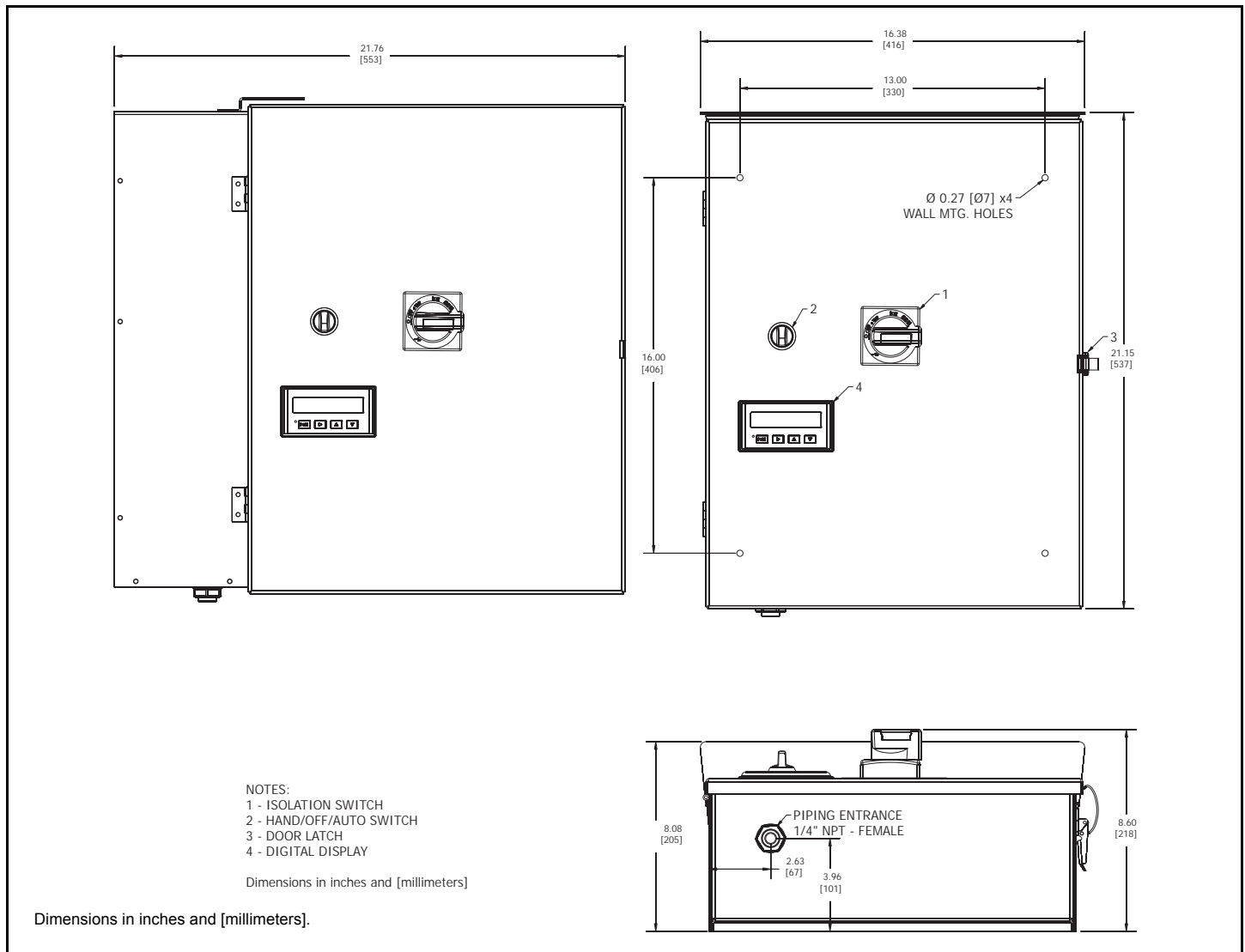

Figure 4: Standard Enclosure - Wye Delta (Star-Delta)



200 - 208V		220 - 240V		380 - 415V		440 - 480V		550 - 600V	
Motor Hp	Withstand Rating (kA)	Motor Hp	Withstand Rating (kA)	Motor Hp	Withstand Rating (kA)	Motor Hp	Withstand Rating (kA)	Motor Hp	Withstand Rating (kA)
0.33 - 3	65	0.33 - 3	65	0.33 - 5	65	0.33 - 7.5	65	0.33 - 10	18
4	50	4	50	7.5 - 10	18	10	50		
5 - 10	18	5 - 10	18			15 - 20	18		
120V 1Ø		240V 1Ø		Approx. Weight					
Motor Hp	Withstand Rating (kA)	Motor Hp	Withstand Rating (kA)	Lbs (Kg)					
0.33 - 0.5	65	0.33 - 2	65	22					
0.75	50	3 - 5	18	(10)					
1 - 2	18								

NOTES:

1. All enclosures finished in Red.
2. Cable Entrance either top or bottom.
3. Standard Enclosure type NEMA 2.





4. Digital Display

The XTJP and XTJY Jockey Pump Controllers are supplied standard with a digital panel meter that indicates the current pressure and Stop and Start pressure set points.

LED Display

- High Visibility Red Superbright LED
- Four full digits
- 0.56in (14mm) high characters
- Flashing Alarms

Ratings

- NEMA 4X
- 1/8 DIN

4.1 Programming

Ensure the Rotary Disconnect switch and the Hand-Off-Auto selector switch are in the OFF position.
Apply power to the Jockey Pump Controller.
Once power is applied, turn the Rotary Disconnect switch to the ON position.

NOTE: The instructions below are based on the factory default settings. Displayed values may vary depending on the programmed parameter setpoint values. Factory default settings for each parameter are listed in Table 1.

4.1.1 Initial Setup

The Digital Display will show the current system pressure.
Press and hold the PGM button.
The display will show "run"

4.1.2 INPUT: (4.20)

While holding the PGM button, press the UP Arrow button.
The display will show "inP"
Release the PGM button
The display is factory set to "4.20".
If the display does not show "4.20", push the RIGHT Arrow button until "4.20" is displayed

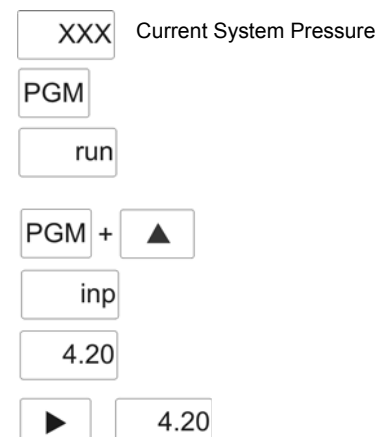

4.1.3 DECIMAL POINT: (1000)

While holding the PGM button, press the UP Arrow button.

The display will show “dp”

Release the PGM button

The display will show “1000”

Do not change the setting.

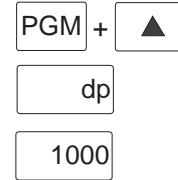

4.1.4 OFFSET Minimum Transducer Pressure: (0 psi)

While holding the PGM button, press the UP Arrow button.

The display will show “OF”

Release the PGM button

The display will show “+0000” – note: the “+” flashes

Do not change the setting.

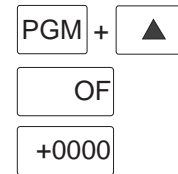

4.1.5 FULL SCALE VALUE Maximum Transducer Pressure: (500 psi)

While holding the PGM button, press the UP Arrow button.

The display will show “FS”

Release the UP Arrow and PGM buttons

The display will show “+0500” – note: the “+” flashes

Do not change the setting.

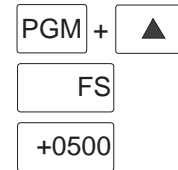

4.1.6 RELAY 1 – Hi ALARM SETPOINT: (+9999)

While holding the PGM button, press the UP Arrow button.

The display will show “1Hi”

Release the UP Arrow and PGM buttons

The display will show “+9999”

Do not change the setting.

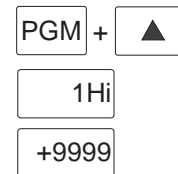

4.1.7 RELAY 1 – Lo ALARM SETPOINT: (+0000) Pressure Start Point

While holding the PGM button, press the UP Arrow button.

The display will show “1Lo”

Release the UP Arrow and PGM buttons

The display will show “+0000”

Push the RIGHT Arrow button to move the value setting position

Set the desired START Point value using the UP and Down Arrow buttons

(eg: For 100psi, the display will show “+0100”)

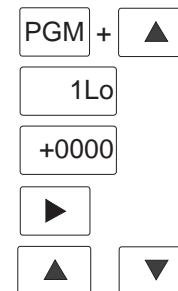

4.1.8 RELAY 2 – Hi ALARM SETPOINT

While holding the PGM button, press the UP Arrow button.

The display will show “2Hi”

Release the UP Arrow and PGM buttons

The display will show “+9999”

Do not change the setting.

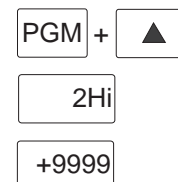

4.1.9 RELAY 2 – Low ALARM SETPOINT

While holding the PGM button, press the UP Arrow button.

The display will show “2Lo”

Release the UP Arrow and PGM buttons

The display will show “-9999”

Do not change the setting.

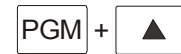

2Lo

-9999

4.1.10 HYSTERESIS (Differential)

While holding the PGM button, press the UP Arrow button.

The display will show “HYS”

Release the UP Arrow and PGM buttons

The display will show “+0000” - note: one of the “0” flashes

Push the RIGHT Arrow button to move the value setting position

Set the desired Differential value using the UP and Down Arrow buttons

(eg: Start Setpoint = +0100psi and the desired Stop Setpoint is 115 psi

Set the HYS (differential) to +0015).

Note: The minimum differential setting is 1psi (+0001).

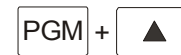

HYS

+0000



4.1.11 RUN

While holding the PGM button, press the UP Arrow button.

The display will show “run”

Release the UP Arrow and PGM buttons

The current pressure is displayed.

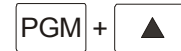

run

XXX

Current System Pressure

Table 1. Parameter Default Settings

Description	Factory Default	Range
Input	4.2	0.10 (0-10V), 1.5 (1-5V), 4.20 (4-20mA)
Decimal Point	1000	1.000 - 1000
Offset	0	-9999 to 9999
Full Scale Value	500	-9999 to 9999
Relay 1 - Hi Alarm Setpoint	9999	-9999 to 9999
Relay 1 - Low Alarm Setpoint (Start Point)	000	-9999 to 9999
Relay 2 – Hi Alarm Setpoint	9999	-9999 to 9999
Relay 2 – Low Alarm Setpoint	-9999	-9999 to 9999
Hysteresis (Differential)	10	0 to 999

This information booklet is published solely for information purposes and should not be considered all-inclusive. If further information is required, you should consult EATON.

Sale of product shown in this literature is subject to terms and conditions outlined in appropriate EATON selling policies or other contractual agreement between the parties. This literature is not intended to and does not enlarge or add to any such contract. The sole source governing the rights and remedies of any purchaser of this equipment is the contract between the purchaser and EATON.

NO WARRANTIES, EXPRESSED OR IMPLIED, INCLUDING WARRANTIES OF FITNESS FOR A PARTICULAR PURPOSE OR MERCHANTABILITY, OR WARRANTIES ARISING FROM COURSE OF DEALING OR USAGE OF TRADE, ARE MADE REGARDING THE INFORMATION, RECOMMENDATIONS AND DESCRIPTIONS CONTAINED HEREIN. In no event will EATON be responsible to the purchaser or user in contract, in tort (including negligence), strict liability or otherwise for any special, indirect, incidental or consequential damage or loss whatsoever, including but not limited to damage or loss of use of equipment, plant or power system, cost of capital, loss of power, additional expenses in the use of existing power facilities, or claims against the purchaser or user by its information, recommendations and description contained herein.